

POWERBOAT GUIDE

ENGINES AND ACCESSORIES

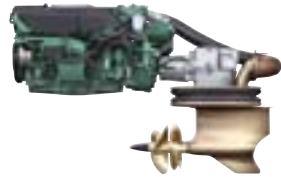

**VOLVO
PENTA**

CONTENTS

Highlights this year	4
Benefits of Volvo Penta power	6
Volvo Penta IPS	10
Aquamatic	18
Diesel inboard	26
Accessories	28
EVC accessory packages	33
Specifications	34

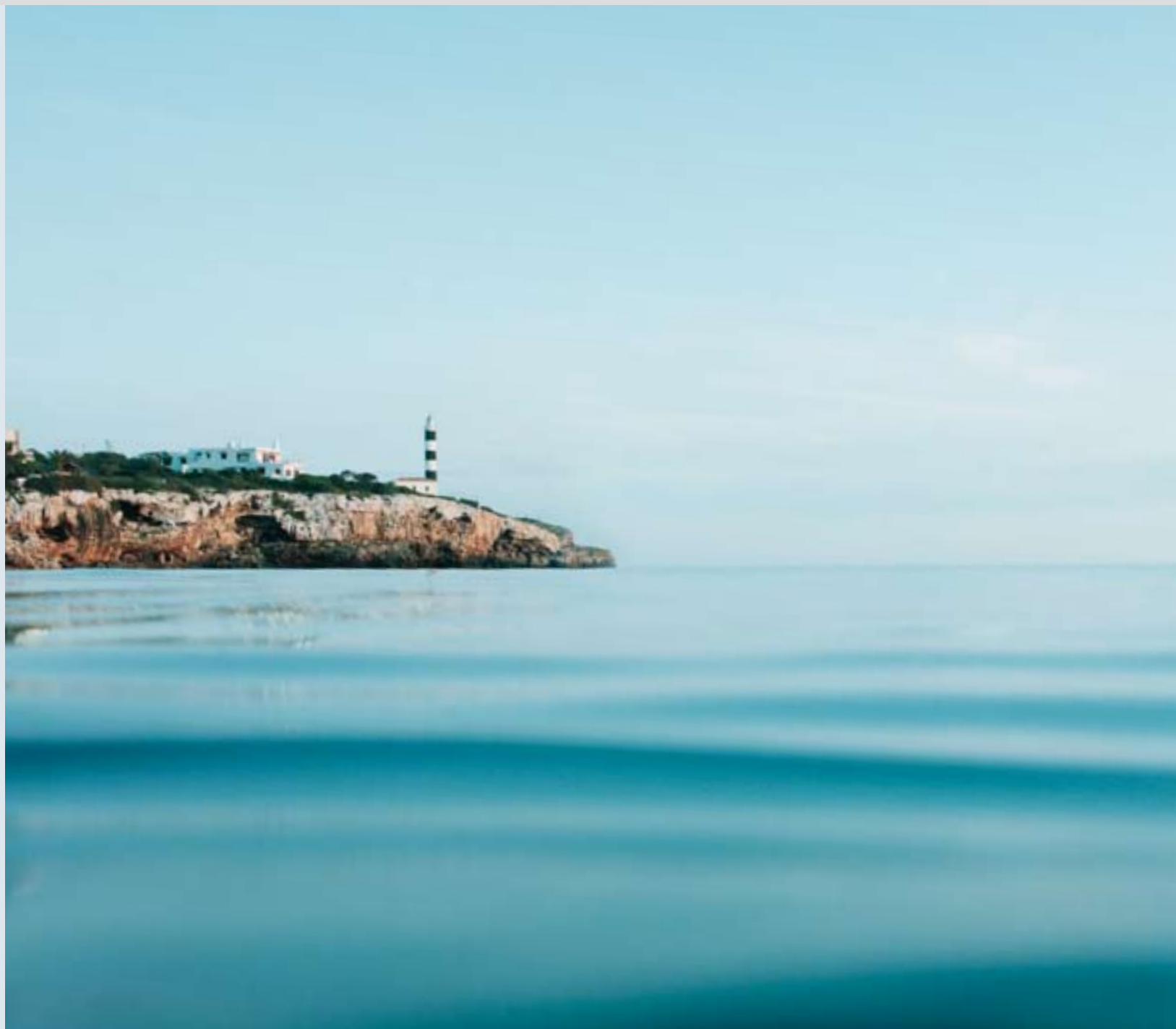



Reducing environmental impact is a global challenge. As industry leaders in leisure boat power, our commitment includes:

- State-of-the-art engines that deliver more performance and less environmental impact.
- Revolutionary propulsion systems that offer a better boating experience and a dramatic cut in CO₂ emissions.
- Smart accessories that enable eco-driving.
- Manufacturing in environmentally certified (ISO 14001) world-class production facilities.

The Volvo Penta Green Commitment is a benefit to you and to the environment.



HIGHLIGHTS THIS YEAR

Welcome to another great boating year with Volvo Penta. With the aim of making your boating life easier and even more pleasant, we have added a number of exciting new products to our already comprehensive range of marine engines, drives and accessories. These are some of this year's highlights.



JOYSTICK FOR AQUAMATIC

Totally intuitive docking – now also for Aquamatic-powered boats! **Page 18**

NEW DISPLAYS

The new standard in engine displays. The information you want, the way you want it. **Page 28**



D13 WITH 900 HP

Extremely fuel efficient inboard engine and more powerful than anything we have ever built before. **Page 27**



THE NEW SPORT DIESELS

Up to 220 hp from the new generation D3. A compact and extremely light engine family with class-leading low emissions. **Aquamatic, page 22. Inboard, page 26**





DYNAMIC POSITIONING SYSTEM

Holds your boat's heading and keeps it within a very limited area automatically. **Page 15**



MORE POWER AND LARGER PODS

The IPS800 and IPS900 make the Volvo Penta IPS benefits available to yachts up to 100 feet. **Page 17**



MORE PERFORMANCE. LESS CO₂

Reducing CO₂ emissions is a challenge Volvo Penta takes seriously and works with constantly. By combining clean engines with efficient drive systems and accessories that enable eco-driving, we are able to offer a seemingly impossible combination: more performance with less CO₂.

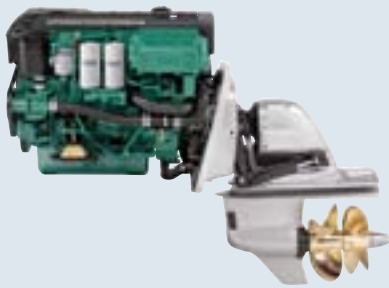

Performance with fuel efficiency

The Volvo Penta common rail diesel Aquamatic offers absolute top-class performance – with 30% less fuel consumption and emissions compared with gasoline alternatives.

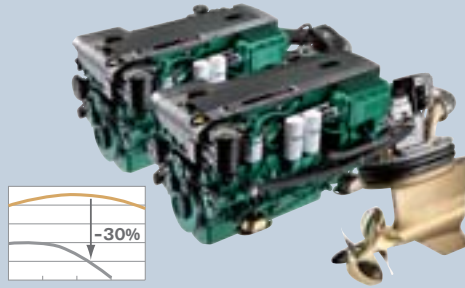

The Volvo Penta IPS revolution

In one stroke, the Volvo Penta IPS reduced fuel consumption and overall emissions by around 30% compared with inboard shafts. A gigantic improvement by any standard.



Exceeds stringent demands

The entire D series diesel engine range complies with the most rigorous environmental demands: US EPA – a regulation significantly more stringent than the European RCD regulation.



Gasoline catalytic converter

Our 4- and 8-cylinder gasoline engines are available with catalytic converters that dramatically reduce emissions. They comply with California's CARB 4 star, the world's most stringent emission regulation.



ECO-DRIVING

Your driving style has a significant impact on fuel consumption and thereby CO₂ emissions. Volvo Penta offers a number of user-friendly accessories to minimize environmental impact.



The Trip Computer with the conforming senders shows instant fuel consumption per nautical mile. An essential tool that makes it easy to adapt speed and trim for optimal efficiency.

Powertrim Assistant gives you the best possible drive trim – automatically and at all speeds. This gives our boat a perfect running attitude for optimum performance.

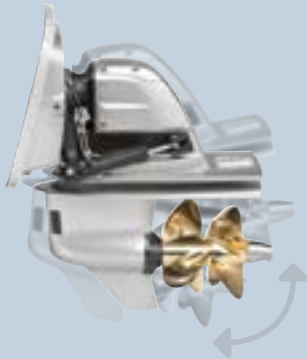

Boat Trim System. Efficient interceptor trim system that quickly gets your boat to the correct trim angle for the least possible water drag.

DEVELOPED FOR MARINE USE

A better boating experience thanks to safe and predictable handling, rapid acceleration, high onboard comfort and excellent reliability. Built on more than 100 years' experience.



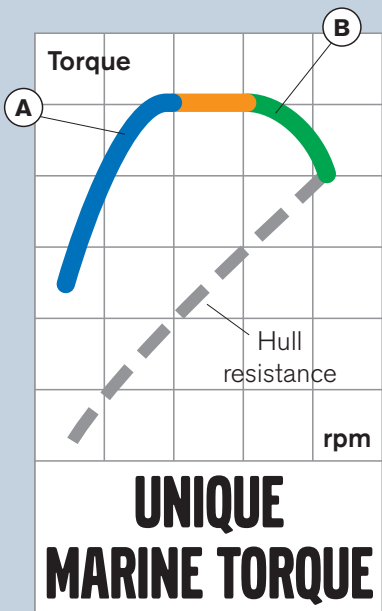

USER-FRIENDLY ELECTRONICS

EVC is Volvo Penta's common Electronic Vessel Control platform with radically reduced wiring and heavy-duty marine connectors. EVC gives greatly improved reliability and new functionality:

- Continuous monitoring of engine and transmission.
- Safety functions protecting transmission and engine.
- Easy to add new functionality.



PERFECTLY MATCHED, THOROUGHLY TESTED

We develop and match everything from engines to transmissions, control systems, drives and propellers. For the boater, this results in higher reliability and better performance.

UNIQUE MARINE TORQUE

The key to maximum performance and maneuvering – full power, and control, when you need it.

- A.** High torque at low rpm gives you:
- Rapid acceleration to plane.
 - Massive maneuvering power.

- B.** At high rpms, full-throttle torque increases if the engine loses rpm. You get:
- Efficient cruising speed even with a fully loaded boat.



DEVELOPED, MANUFACTURED AND SERVICED BY ONE COMPANY

Volvo Penta gives you one single contact for the whole package.

VOLVO PENTA IPS – A GROWING STANDARD

10,000 Volvo Penta IPS units delivered, available in more than 250 boat models worldwide. Praised by owners, the press and boat builders, it's now time for the next phase. With more power and a larger pod, the benefits of forward facing are now available for yachts all the way up to 100 feet.



The new IPS900 is powered by an 11-liter marine diesel with excellent torque – perfectly handled by the new larger pod and propellers.

A completely new, yacht-sized system

With the new IPS800 and IPS900, powered by the D11 engine, the unique benefits of Volvo Penta IPS are now also available for yachts up to 100 feet. The key to this success is a whole new package where engine, pod and propellers have been developed in parallel to match each other perfectly. The new pod is significantly

larger to efficiently handle the impressive power and torque of the D11 engine. In practice, this means that the efficiency and reliability of Volvo Penta IPS are maintained – to the full – in the new yacht-sized generation.

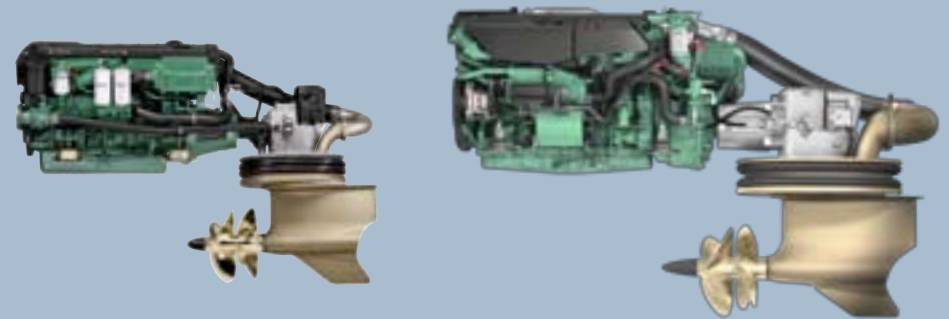

Both the IPS600 and the IPS900 are perfectly matched to their respective power and torque. With 2.5 times higher torque and 70% larger propeller blade area, the new IPS900 offers equivalent performance for yachts up to 100 feet.



BENEFITS OF VOLVO PENTA IPS:

- 30% less CO₂ emissions.
- 30% reduced fuel consumption.
- 20% higher top speed.
- 50% lower perceived noise level.
- Car-like handling.
- Joystick docking.

Compared with inboard shafts, approximate figures.



Now, the forward-facing benefits is taken to yachts up to 100 feet. This 92-foot yacht is powered by 4 X IPS900. With a displacement of over 60 tons, the cruising range is close to 450 NM at 28 knots. All Volvo Penta IPS features are included: joystick docking, Dynamic Positioning System and Low-speed mode.

WHY FORWARD FACING IS SO SUPERIOR

The forward-facing system offers new and groundbreaking solutions that give superior efficiency, very low noise and vibrations, car-like driving, easy docking and hassle-free ownership.

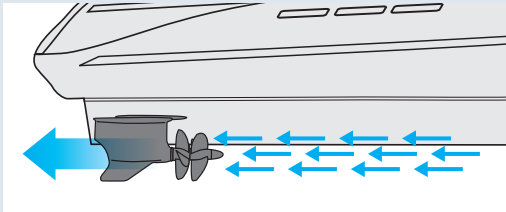
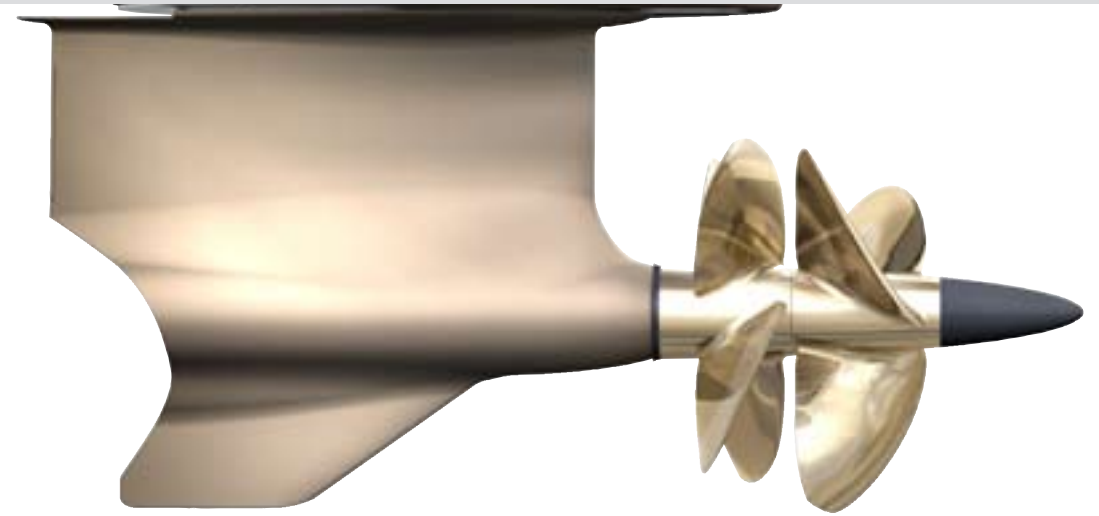

Forward-facing efficiency

The twin counter-rotating propellers face forward, working in undisturbed water. The propeller thrust is parallel with the hull. All power drives the boat forward.

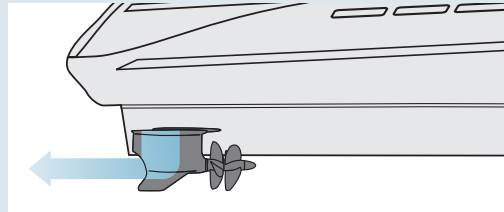

Virtually no fumes

All exhaust fumes are emitted through the pods, into the propwash and carried well behind the boat.

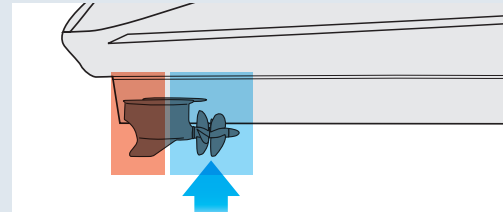

Cavitation free

The propellers are positioned well under the hull to eliminate the risk of air intrusion and cavitation, even in sharp turns and under full acceleration.

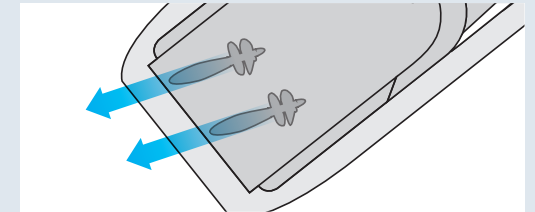

Steerable pods

Steerable pods point the entire thrust in the desired direction. This gives immediate response and totally predictable handling.



BLADE AREA EQUALS PROPULSION EFFICIENCY

Forward-facing propellers, with no exhausts through the hub, minimize the hub diameter. This gives a proportionally much larger active blade area in the water. This is one of the secrets behind the unbeatable efficiency of the Volvo Penta IPS system.

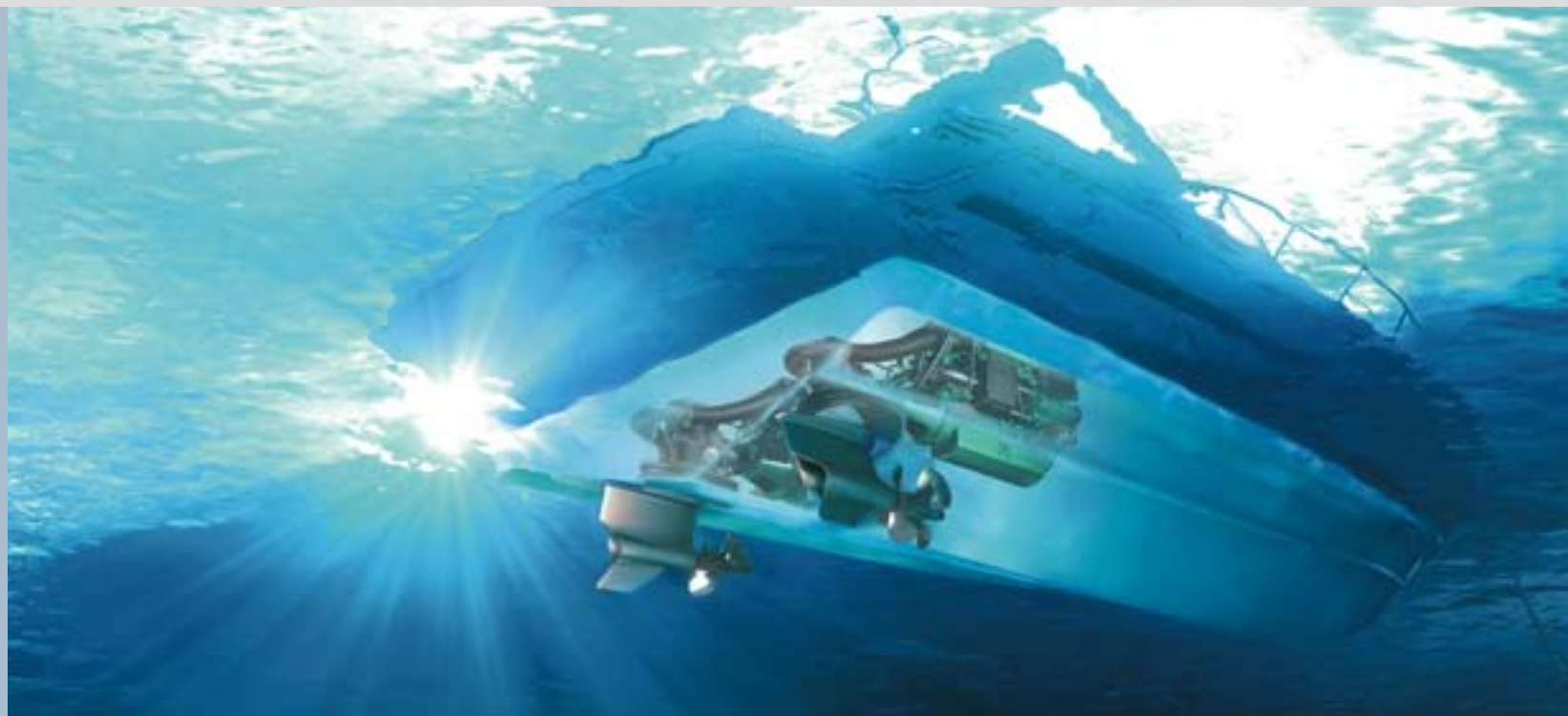

HASSLE-FREE OWNERSHIP

With Volvo Penta IPS you have one contact for everything from helm to props, which is a great advantage. The whole propulsion system consists of standard Volvo Penta components supported by the global Volvo Penta dealer network.

BUILT-IN SAFETY

Designed with safety as a key feature in every sense of the word, Volvo Penta IPS offers a robust construction, flexible suspended pods and redundancy in the EVC system. Volvo Penta IPS also has a series of built-in features to reduce the risk of leakage in the event of an impact. Excellent maneuverability with one engine increases safety still more.

EASIER BOATING

With Volvo Penta IPS you get easier boating thanks to a number of optional accessories. You can concentrate on the fun part of boating and enjoy your days at sea with precise control and increased safety.

JOYSTICK AND DOCKING STATION

The skipper's best friend that makes docking easy, even fun! Simply move the joystick in the direction you want the boat to move, and the boat reacts to your intentions. Forward, reverse, sideways, spin around etc.

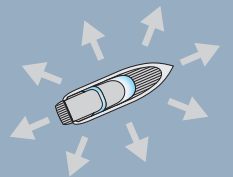
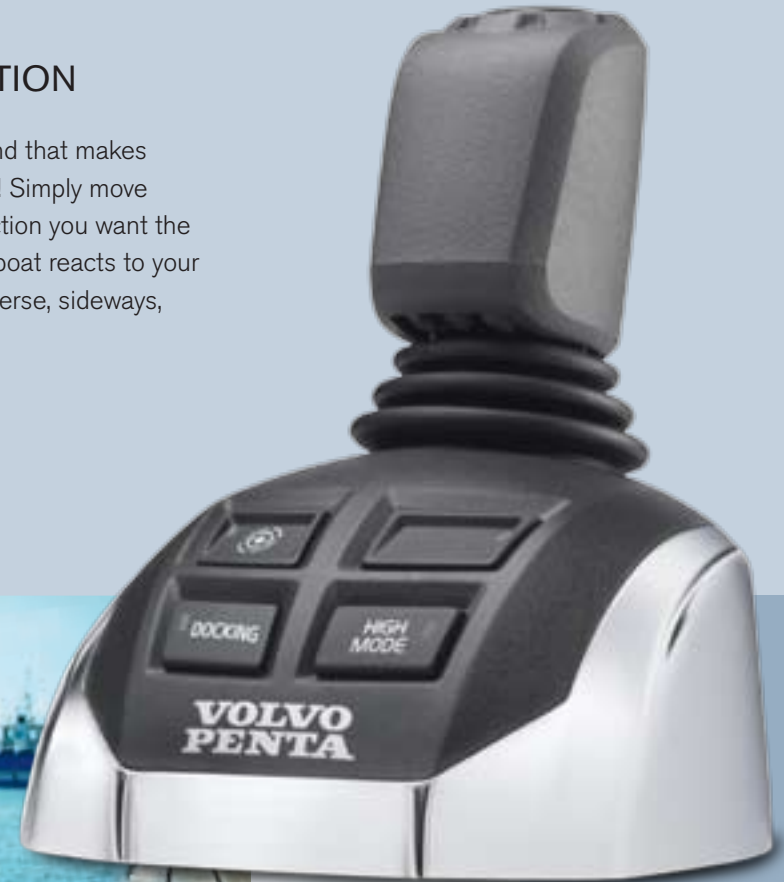

With the docking station, the boat is equipped with an additional Volvo Penta IPS joystick. Place the docking station where you have the best possible view for maneuvering. Up to four joysticks can be installed.

The new Volvo Penta IPS joystick features ergonomic design and push-button control for joystick engagement, high mode and Dynamic Positioning System.

DYNAMIC POSITIONING SYSTEM

Press a button and the new Dynamic Positioning System holds your boat's heading and keeps it within a very limited area, even in a current or in windy conditions. A perfect feature for waiting at the fuel dock or for a bridge or lock to open. When docking, the Dynamic Positioning System gives your crew time to prepare fenders and lines.

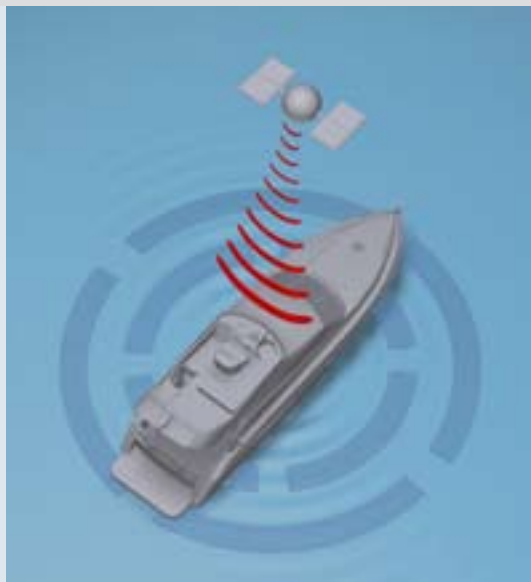

Twin high-precision GPS receivers determine the boat's position and heading. Software in the EVC system transforms this data into steering angles, gear shifts and throttle positions to keep the boat still.



The antenna with twin GPS receivers feeds positioning information to the Dynamic Positioning System. The system is activated and deactivated by pushing a button on the new joystick and the 7" display shows system status.



SPORTFISH MODE

A Volvo Penta unique feature for big-game fishing:

- The pods are locked toe-out.
- The driver can turn the boat rapidly using control levers.
- Easy to follow the fish, and bring home the catch!

LOW-SPEED MODE

Now you can drive seamlessly with the standard controls, from very low speed to full speed. Perfect when driving in marinas and canals, plus it is ideal for trolling. The low-speed mode works by a slip coupling in the gearbox that reduces boat speed at idling by approximately 50%, from 5-6 knots to 2-3 knots.

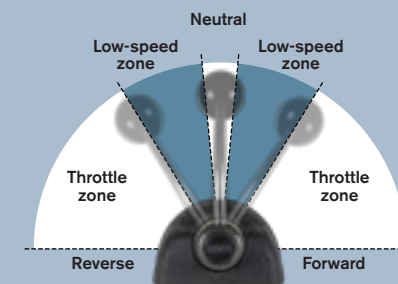

The Low-speed mode is integrated in the standard controls and gives smooth control from very low speed to full speed.

VOLVO PENTA IPS RANGE

The Volvo Penta IPS range features eight models, suitable for boats and yachts from 35 to 100 feet. New models this year are the IPS800 and IPS900, both powered by the D11 marine diesel. The range also features one gasoline model, the only gasoline-powered pod on the market.

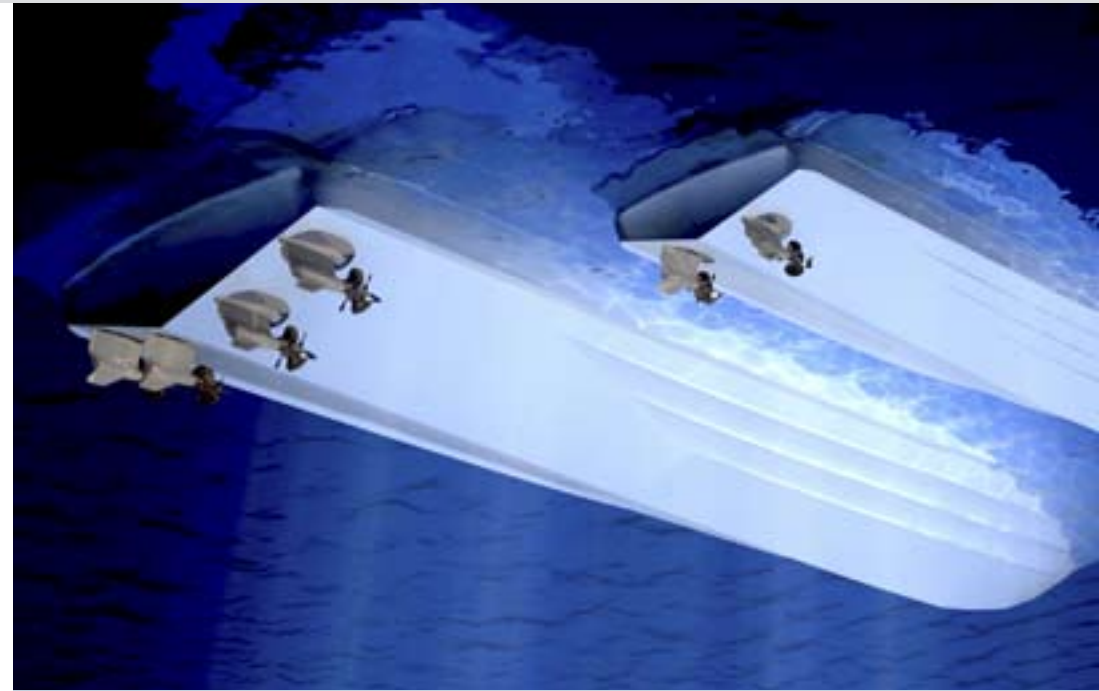

Multiple opportunities

Volvo Penta IPS is available for twin, triple and quadruple installation. This means there is a perfect power option for boats, yachts and cruisers all the way up to 100 feet. All equally easy to drive with standard twin controls and all options available.

IPS550G

V8-powered gasoline with catalytic converter at 400 hp. Available in selected markets.



The Dynamic Positioning System is not available for IPS550G.

IPS350 AND IPS400

Powered by the D4, a 3.7-liter, 4-cylinder EVC-managed, common-rail diesel with turbo, compressor and aftercooler. 260 and 300 hp.

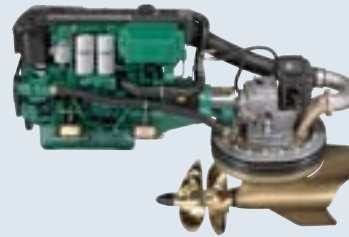

IPS450, IPS500 AND IPS600

Powered by the 6-cylinder D6, this 5.5-liter, EVC-managed common-rail diesel with turbo, compressor (500 and 600) and aftercooler delivers 330, 370 and 435 hp.

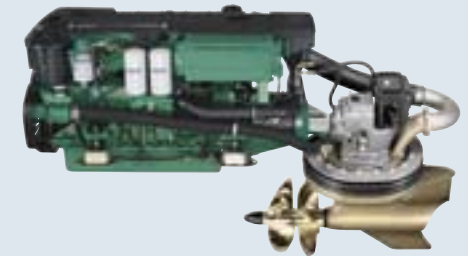

Integrated, hydraulic reverse gear for smooth and fast-acting shifts.

Propulsion forces and vibrations are absorbed by the combined, twin rubber suspension and sealing rings.

Unique, steerable pod with integrated seawater and exhaust system.

Exhaust fumes are emitted into the prop wash and carried well behind the boat.

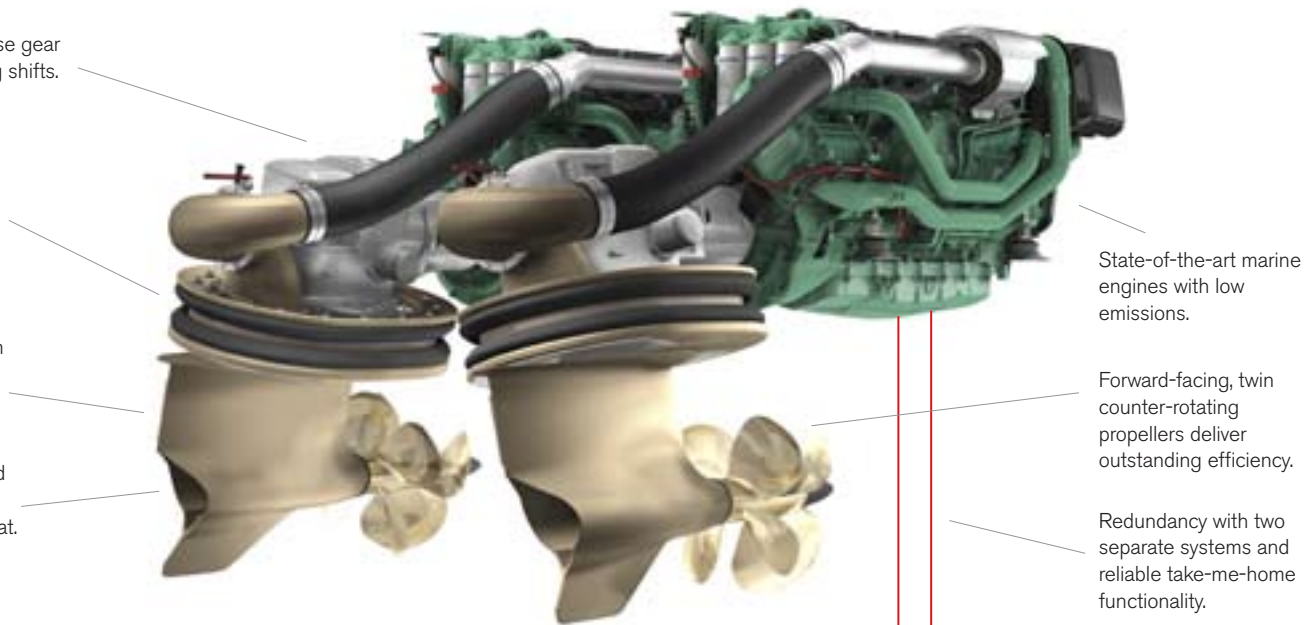

State-of-the-art marine engines with low emissions.

Forward-facing, twin counter-rotating propellers deliver outstanding efficiency.

Redundancy with two separate systems and reliable take-me-home functionality.

Up to 4 helm stations possible.

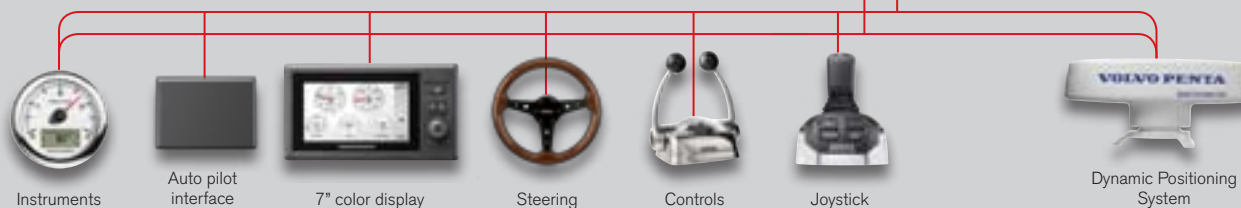

IPS800 AND IPS900

Powered by the 6-cylinder D11. An 11-liter, EVC-managed diesel with twin entry turbo, mechanical compressor and after-cooler delivering 600 and 700 hp.

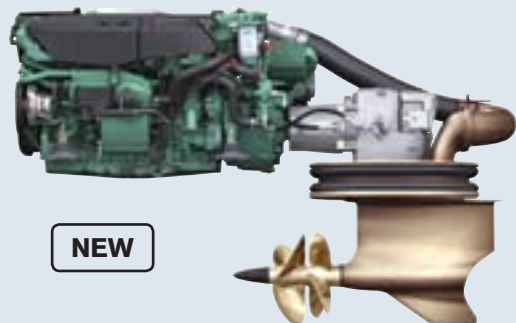

Quadruple installation of Volvo Penta IPS600.

EVC features

Electronic controls (shift & throttle)	●
Engine protection	●
Engine monitoring	●
Engine diagnostics	●
Engine synchronization	●
Up to 4 helm stations	●
Transmission protection	●
Engine alarms in text	●
Plug-in instrument installation	●
NMEA 2000 interface	○
Trip computer	○
Instrumentation dimmer	●
Depth, seawater temp and speed	○
Joystick	○
Docking station	○
Autopilot interface ³⁾	○
Sportfish mode	○
Low-speed mode ¹⁾	●/○
Dynamic Positioning System ²⁾	○

● Standard ○ Option

¹⁾ Standard on IPS800 and IPS900, optional for other diesel models.

²⁾ Requires low-speed mode and 7" display. Only diesel models.

³⁾ Volvo Penta certifies marine autopilot manufacturers for compatibility with the Volvo Penta IPS.

What is standard or optional varies by market.

Accessory packages
Read more on page 33.

Power range

Diesels	Power (hp)	Engine
IPS350	260	D4
IPS400	300	D4
IPS450	330	D6
IPS500	370	D6
IPS600	435	D6
IPS800	600	D11
IPS900	700	D11
Gasoline	Power (hp)	Engine
IPS550G	400	V8

Complete technical data on page 34.

AQUAMATIC NOW WITH JOYSTICK DOCKING

The joystick puts you in total control and lets you move your boat in any direction – sideways, diagonally, forwards, backwards or rotate – with just one hand. From this year, available for Aquamatic as an option.

Introducing sterndrive joystick

Control your boat totally intuitively: move sideways, diagonally, forward, spin around or any combination. Docking and close-quarter maneuvering becomes easy and fun! The joystick is provided with electronic steering and is available for twin installations from model year 2010 – for diesels and gasoline V8 engines.

Electronic controls

Electronic controls for shift and throttle are now standard on all diesel models and available for all gasoline models (except 3.0). Among the benefits are precise control, lower noise and practically no service required.

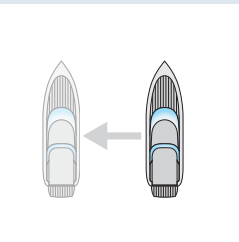

Push the joystick to port or starboard and your boat goes sideways. Even "impossible" berths are now accessible.

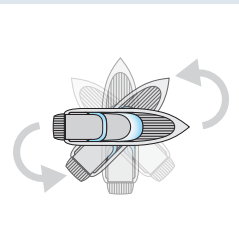

Twist the top to rotate. Combine it with any other move to compensate for wind or current.

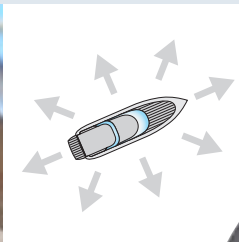

You can do all your slow-speed driving with the joystick. Much easier than the conventional way!



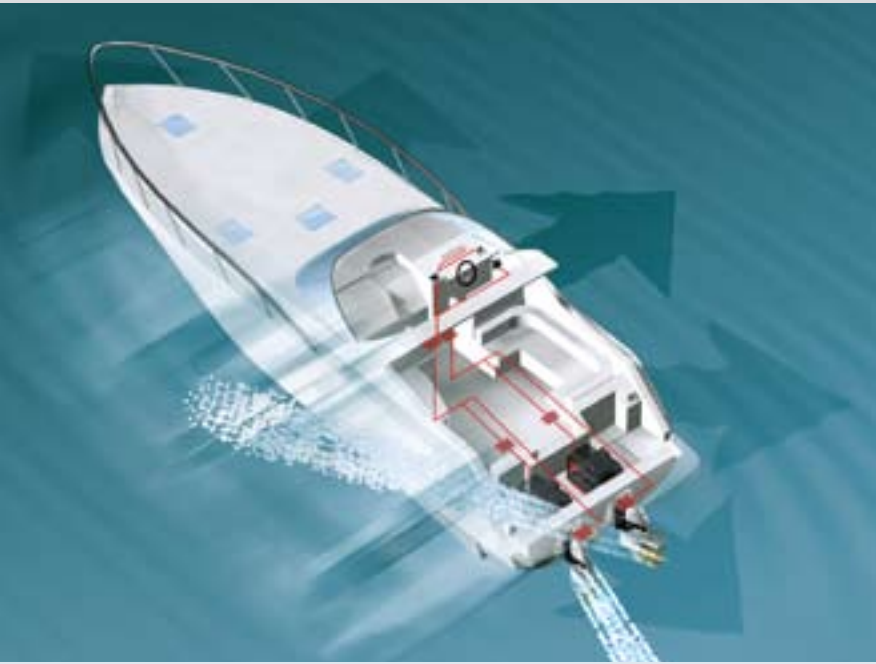

No need for bow thrusters – the individually steerable drives move the boat in the desired direction.



The Volvo Penta IPS success is now available also for Aquamatic. You can move your boat in any conceivable direction – with just the joystick. Special software transforms your joystick commands to boat movements by controlling engine rpm and gear shift plus the individually steerable Aquamatic drives.

THE UNIQUE BENEFITS OF AQUAMATIC

Developed, manufactured and serviced by one company. That is the key to Volvo Penta's undisputed leadership in sterndrive technology. Perfectly matched – from controls to engine, drive and propellers – these packages deliver high performance and sporty handling. And, as a result of the Aquamatic efficiency, it offers low CO₂ levels and the most comfortable sterndrive experience on the market.

BENEFITS OF AQUAMATIC:

- Low fuel consumption.
- Low CO₂ emissions.
- Sporty performance.
- Powertrim Assistant as option.
- Very high onboard comfort.
- Excellent low-speed maneuverability.
- Joystick docking as option.

SPORTY AND COMFORTABLE

With excellent driving feel at all speeds, Volvo Penta Aquamatic gives sport performance to boats from 17 to over 45 feet. In addition, its noise and vibration levels are strikingly low. Underwater exhaust and clean engines mean practically no fumes or smell. A clean, uncluttered transom benefits fishing and swimming.



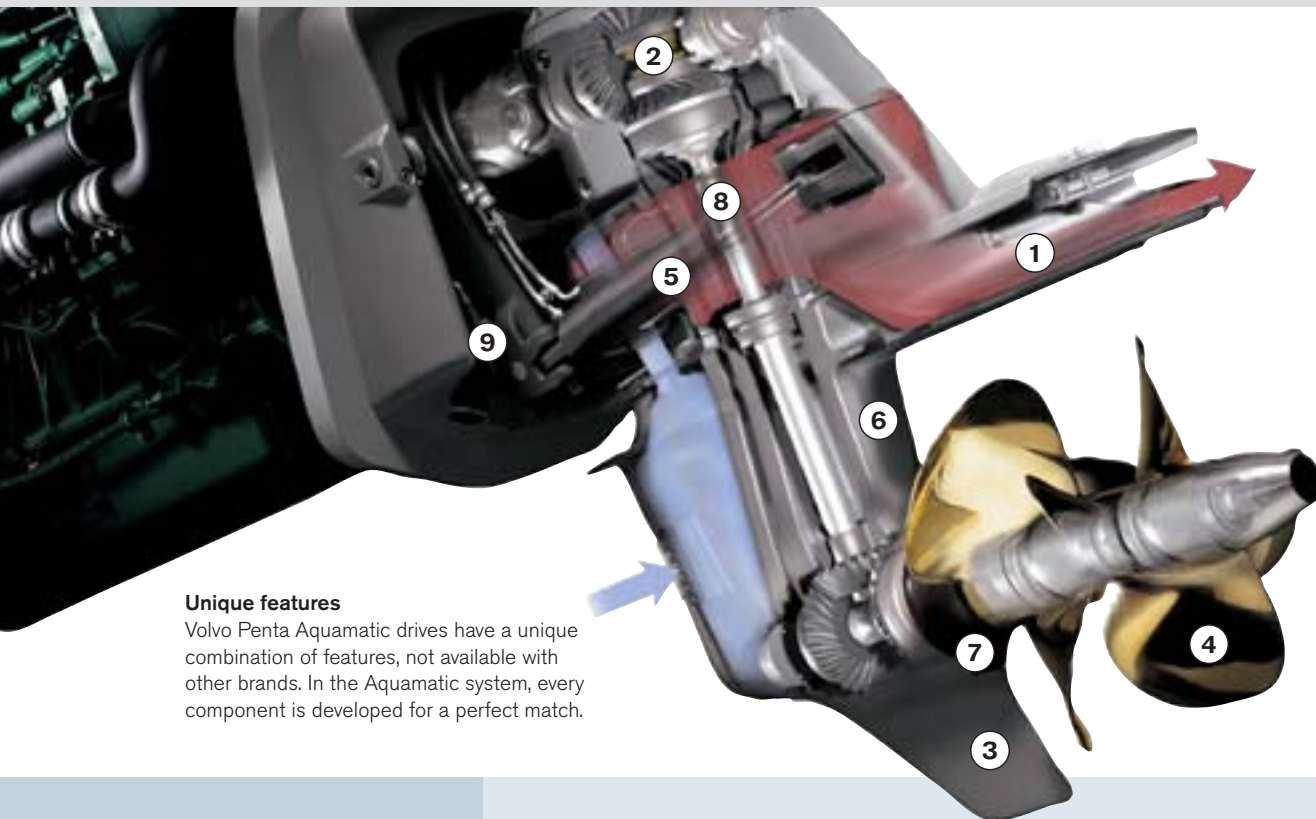

Unique features

Volvo Penta Aquamatic drives have a unique combination of features, not available with other brands. In the Aquamatic system, every component is developed for a perfect match.

1. Genuine through-the-drive exhaust leads fumes away and reduces noise.
2. Smooth shifting and exceptional durability with patented cone clutch.
3. Excellent corrosion resistance from saltwater-grade aluminum and multi-layer paint process.
4. Patented nickel-bronze-aluminum alloy propellers: extremely strong, corrosion and growth-resistant (DPH).
5. Patented, fully hydraulic and X-act steering with direct-mounted, external steering cylinders (DPH and DPR).
6. Hydrodynamically designed lower housing reduces drag and increases performance.
7. Patented “booster ring” that optimizes water flow to the propellers.
8. The break-away shaft coupling is designed to protect the transmission by shearing if the propellers strike a submerged object at speed.
9. Hydraulic powertrim with integrated kick-up function minimizes damage if a large underwater object is struck.

SINGLE PROP



SX

Perfect reliability and performance. Hydrodynamic design and low weight for better speed and performance. For D3 and gasoline engines.

DUOPROP



DPS

For D3 diesels and 4.3-8.1L gasoline engines, providing amazing driving feel and safety. Hydrodynamic design and low weight for higher speed and better performance.



DPR

High-speed version of the DPH drive for the D4 and D6, delivering perfect control for boats with top speeds above 45 knots.



DPH

Developed to handle the tremendous torque of the D4 and D6 diesel engines. External hydraulic steering cylinders, patented X-act steering and propellers give optimum driving safety and enjoyment.



New OceanX

For D3 diesels and 4.3-8.1L gasoline engines. Expressly developed titanium-ceramic coating and a drive monitoring sensors package (gasoline only) applied to our base DPS drive. Available only in selected markets.

DIESEL AQUAMATIC RANGE

The diesel Aquamatic range is from 140 to 370 hp, giving sport performance to boats from 17 to over 45 feet. Complete packages with common-rail diesels, matched drive and propellers, and electronic controls as standard on all models. The new generation of D3 comes with increased performance and lower emissions than ever.



Sport diesels

The new D3 generation takes diesel engine technology one step further. This high-performing and lightweight diesel engine is a class leader when it comes to low emissions.

D3 - IMPRESSIVE PERFORMANCE

Sport performance from a completely new in-line, 5-cylinder, common-rail diesel with up to 220 hp. Robust design and electronic controls as standard. Complies with the world's most stringent emission demands. Compact and light - only 363 kg complete with DPS drive.

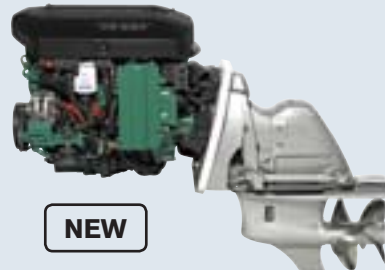

NEW

Drives: **SX** or **DPS**.

D4 - COMPACT AND POWERFUL

A compact, compressor and turbo-charged, 3.7-liter, common-rail diesel with 225, 260 or 300 hp. Comparable to V8 big-block gasolines in performance and size - at about half the fuel consumption. Enhanced onboard comfort thanks to integrated balance shafts and fully optimized engine mounts.

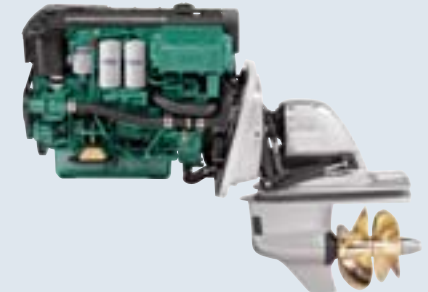

Drives: **DPH** or **DPR**.

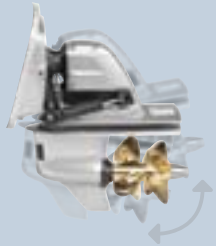

Powertrim Assistant

Gives you optimum drive trim – automatically and at all speeds. Your boat gets a perfect running attitude for optimum performance with lower fuel consumption and, thus, CO₂ emissions.



Joystick docking

The joystick is now also available for Aquamatic. Simply move the joystick in the direction you want the boat to move, and the boat reacts to your intentions.

D6 – THE WORLD’S MOST POWERFUL DIESEL STERNDRIVE

The D6 with its 330 or 370 hp has opened up Duoprop benefits for boats up to +45 feet. Common rail, 6 cylinders, in-line, 5.5 liter displacement, mechanical compressor on the 370 version.



Drives: DPH or DPR.



EVC features

Electronic controls (shift & throttle)	●
Engine protection	●
Engine monitoring	●
Engine diagnostics	●
Engine synchronization	●
Up to 4 helm stations	●
Transmission protection	●
Engine alarms in text	●
Plug-in instrument installation	●
NMEA 2000 interface	○
Trip computer	○
Instrumentation dimmer	●
Depth, seawater temp and speed	○
Joystick ^{1,2)}	○
Docking station ^{1,2)}	○
Autopilot interface ^{1,2,3)}	○
Electronic steering ¹⁾	○
Powertrim sync	●
Powertrim Assistant	○
Adjustable trim limits	●

● Standard ○ Option

¹⁾ Twin installation. DPS and DPH drives.

²⁾ Requires electronic steering.

³⁾ Volvo Penta certifies marine autopilot manufacturers for compatibility with Volvo Penta Aquamatic.

What is standard or optional varies by market.



Accessory packages
Read more on page 33.

Power range

	Power (hp)			
D3	140	170	200	220
D4	225	260	300	
D6	330	370		

Complete technical data on page 35.

GASOLINE AQUAMATIC RANGE

Sporty boating with the 4-, 6- and 8-cylinder packages delivering gasoline performance. The 4- and 8-cylinder models are available with catalytic converters that dramatically reduce emissions to a level that complies with California's CARB 4 Star and meets the upcoming US EPA emission requirements.



Catalytic converter

Our 4- and 8-cylinder gasoline engines are available with catalytic converters that dramatically reduce emissions to a level that complies with California's CARB 4 Star Super Ultra Low emission requirements and meets the US EPA emission requirements that will take effect January 2010.

3.0 - COMPACT 4-CYLINDER ENGINE

Lightweight 4-cylinder engine with powerful torque and 135 or 150 hp.

Drive: SX.



4.3 - SMOOTH-RUNNING V6

Virtually vibration-free running thanks to a centrally mounted balance shaft. Available with carburetor or MPI. 190 or 225 hp.

Drives: SX or DPS



5.0/5.7 - SMALL-BLOCK V8

The small-block V8s come with 5.0 and 5.7 liter displacement with carburetor* or MPI. Six power options from 220 to 320 hp.

Drives: SX or DPS.





EVC features

Electronic controls (shift & throttle) ¹⁾	●/○
Engine protection ²⁾	●
Engine monitoring ²⁾	●
Engine diagnostics ²⁾	●
Engine synchronisation ²⁾	●
Transmission protection ²⁾	●
Engine alarms in text ²⁾	●
Plug-in instrument installation ²⁾	●
NMEA 2000 interface ²⁾	○
Trip computer ²⁾	○
Instrumentation dimmer ²⁾	●
Depth, seawater temp and speed ²⁾	○
Electronic steering ^{2,3)}	○
Powertrim sync ²⁾	●
Powertrim assistant ²⁾	○
Adjustable trim limits ²⁾	●
Tow mode ⁵⁾	○
Joystick ^{2,3,4)}	○
Docking station ^{2,3,4)}	○
Autopilot interface ^{2,3,4,6)}	○

● Standard ○ Option

¹⁾ Option for 3.0 and non-EVC engines. ²⁾ Requires EVC.
³⁾ Twin installation, V8, DPS drives. ⁴⁾ Requires electronic steering.
⁵⁾ Requires EVC, single installation.
⁶⁾ Volvo Penta certifies marine autopilot manufacturers for compatibility with Volvo Penta Aquamatic.

What is standard or optional varies by market.



Accessory packages
 Read more on page 33.



New Tow mode for water sport

The Tow mode makes tubing, wake boarding and waterskiing easier, safer and more fun. Tow mode automatically accelerates to your pre-set engine speed and maintains that speed for maximum water sport fun.



Joystick docking

Now, joystick is available also for Aquamatic. Simply move the joystick in the direction you want the boat to move, and the boat reacts to your intentions.

8.1 - BIG-BLOCK V8

Big-block V8, the ultimate in gasoline power at 375, 400 and 420 hp. The 8.1 features electronic fuel injection with advanced monitoring system to ensure high reliability.

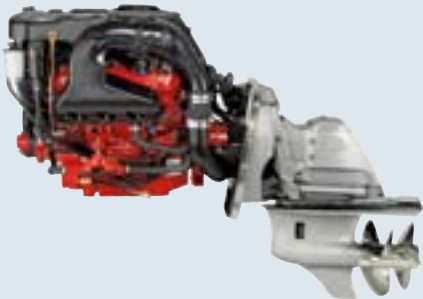

Drive: DPS.



Power range

	Power (hp)			
3.0	135	150*	150	
4.3	190	225		
5.0/5.7	220	270	300	320
		270	300	
8.1	375	400	420	

with catalytic converter

Complete technical data on page 35.

DIESEL INBOARD RANGE

The D3 and D13 engines are this year's exciting new arrivals in Volvo Penta's range of fuel-efficient marine diesels for inboard shaft installations. With the new powerful D13, the D series range goes all the way up to 900 hp.



D1 AND D2 – THE COMPACT PERFORMERS

Low-rpm diesels for minimal vibrations and noise. 115 A alternator and built-in charging sensor for optimum battery charging. 2, 3 or 4 cylinders, 12 to 75 hp.



D3 – VERSATILE PERFORMER

The new generation in-line 5-cylinder diesels with very low exhaust and noise emissions. Five output options from 110 to 220 hp; two are low-rev versions for displacement boats. Electronic controls are standard on all models.



D4 AND D6 – HIGH-TECH POWER

Common rail, EVC and 4-valve technology deliver 180 to 435 hp. Smooth running with further reduced vibrations thanks to optimized engine suspension.





NEW

D13 – MOST POWERFUL EVER

The D13 gives you 900 hp with a great low-end torque. This power comes with low fuel consumption and low exhaust emissions. With the unique twin-entry, dual-stage turbo and twin-charged air coolers you will be amazed by its performance. The design is very compact and service friendly.

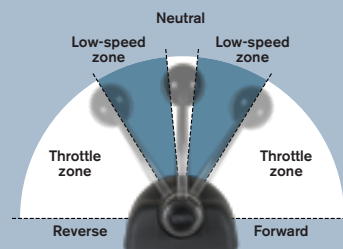

Low-speed mode

Provides easy maneuvering and docking by reducing boat speed at idling by approximately 50%. Integrated in standard controls.

EVC features

Electronic controls (shift & throttle) ¹⁾	●/○
Engine protection ²⁾	●
Engine monitoring ²⁾	●
Up to 4 helm stations.	●
Engine diagnostics ²⁾	●
Engine synchronization ²⁾	●
Transmission protection ²⁾	●
Engine alarms in text ³⁾	●
Plug-in instrument installation ²⁾	●
NMEA 2000 interface ²⁾	○
Trip computer ²⁾	○
Instrumentation dimmer ²⁾	●
Depth, seawater temp and speed	○
Low-speed mode ^{2) 4)}	●/○

● Standard ○ Option

¹⁾ Option for D1/D2.

²⁾ D3-D13.

³⁾ D1/D2 has alarm symbols.

⁴⁾ Standard on D13 with MXG gearbox.

What is standard or optional varies by market.



Accessory packages
Read more on page 33.

D9 AND D11 – MASSIVE TORQUE

Extremely powerful at all engine speeds, yet compact in size. The unique twin-entry turbo enables pulse charging, creating a magnificent torque for powerful acceleration. Easy to service, with all fuel and oil filters at the back of the engine. 500 to 670 hp.



D12 – THE BENCHMARK

The D12 with 715 and 775 hp is one of Volvo Penta's most successful engines ever. It has set a standard that is matched only by the newer D11 and D13.



Power range

	Power (hp)				
D1	12	19	28		
D2	40	55	75		
D3	110	150	170	200	220
D4	180	225	260	300	
D6	330	370	435		
D9	500	575			
D11	670				
D12	715	775			
D13	900				

Complete technical data on page 34.

CUSTOMIZE YOUR BOATING

Clever accessories help improve performance, as well as safety and comfort. This year we present the new easy-to-navigate 2.5" display and the ingenious 7" full color display that you can easily tailor to your specific needs.

The EVC system makes multi-information displays possible. In these displays you can get engine data, receive information and messages and manage the various EVC functions.

7" full color display - New!

Top-of-the-line with full color. Operation is intuitive thanks to the easy-to-understand menus.

4" display

Can show data from two engines at the same time. Five push-buttons make it easy to navigate.

2.5" display - New!

2.5" display for Volvo Penta gasoline engines. Easy to navigate with backlit push-buttons.

Tachometer with LCD window

Easy to navigate the LCD window with the turning knob on the EVC main panel.

Trip Computer software

As an option in combination with the multi-information displays and the tachometer, you can get full trip computer functionality. For available data, see the table.

NMEA 2000 interface

The NMEA 2000 interface, combined with a compatible chart plotter, is complementary to a multi-information display. It makes it possible to display engine data and alarms in the plotter.

INSTRUMENTATION



The 7" full color display shows all available information, the way you want it. Digital or analogue readers, your tailored view or standard view, etc. Active software functions, such as Low-speed mode, is displayed. There is also a video input for an onboard camera. Operation is intuitive thanks to the easy-to-understand menus.



Easy-to-navigate menu leads you quickly to the information that you want.



The fuel economy view gives you detailed information on your boat's current and average fuel economy.



With a camera connected, you can monitor the engine room or get better stern visibility for increased safety.

Multi-information displays



2.5" display



4" display

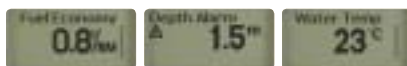

Tachometer with LCD window

Features and data	2.5"	4"	7"	Tacho-meter
Color screen			•	
Day/Night mode			•	
Pop-up menus (short cuts)			•	
Video input			•	
Neutral beep (on/off)	•	•	•	•
Engines displayed (max)	1	2	3	1
Engine rpm	•	•	•	•
Engine hours	•	•	•	•
Coolant temperature	•	•	•	•
Voltage	•	•	•	•
Oil pressure *	•	•	•	•
Turbo pressure (diesel) *	•	•	•	•
Alarms and warnings	•	•	•	•
Diagnostics in text	•	•	•	•
Diagnostics in text, extended info			•	
Transmission, oil pressure **	•	•	•	•
Transmission, oil temperature **	•	•	•	•
Boat speed ¹⁾	•	•	•	•
Fuel level ²⁾	•	•	•	•
Fresh water level ²⁾	•	•	•	•
Depth with alarm ²⁾	•	•	•	•
Sea water temperature ²⁾	•	•	•	•
Rudder angle ²⁾	•	•	•	•
Powertrim angle (Aquamatic)	•	•	•	•
Active Corrosion Protection info ³⁾	•	•	•	•
Low-speed mode, slip rate ⁴⁾	•	•	•	•
With Trip Computer software	○	○	○	○
Instant fuel rate	•	•	•	•
Trip time	•	•	•	•
Trip fuel	•	•	•	•
Average fuel rate	•	•	•	•
Time to empty	•	•	•	•
Instant fuel economy ¹⁾	•	•	•	•
Trip distance ¹⁾	•	•	•	•
Average fuel economy ¹⁾	•	•	•	•
Distance to empty ¹⁾	•	•	•	•
With Dynamic Positioning System	○	○	○	○
Bearing			•	
Direction of movement			•	
GPS signal strength			•	

* Not available for D1 and D2. ** Depending on transmission. Requires sensors. ○ = Option.

- 1) Requires extra sensor or NMEA interface.
- 2) Requires extra sensor.
- 3) Volvo Penta IPS. Requires Active Corrosion Protection.
- 4) Requires Low-speed mode



Complete instrument range

Built to the highest marine standards with anti-fogging membrane and full backlighting. Thanks to the EVC, installation with serial connections is easy.

Main instruments

- Tachometer with info display (85 mm and 110 mm).
- Speedometer (requires sensor, 85 mm and 110 mm).

4-in-1 instrument

Fuel level, coolant temperature, voltage and oil pressure for inboard, or trim position for Aquamatic (110 mm).

52 mm instruments

Coolant temperature; trim position, analogue reading; trim position, digital reading; fuel tank level; rudder position; water tank level; turbo pressure; battery voltage; engine oil pressure.

Auxiliary Dimmer Unit

Lets you control the lighting of all instruments, regardless of make.

DRIVEABILITY

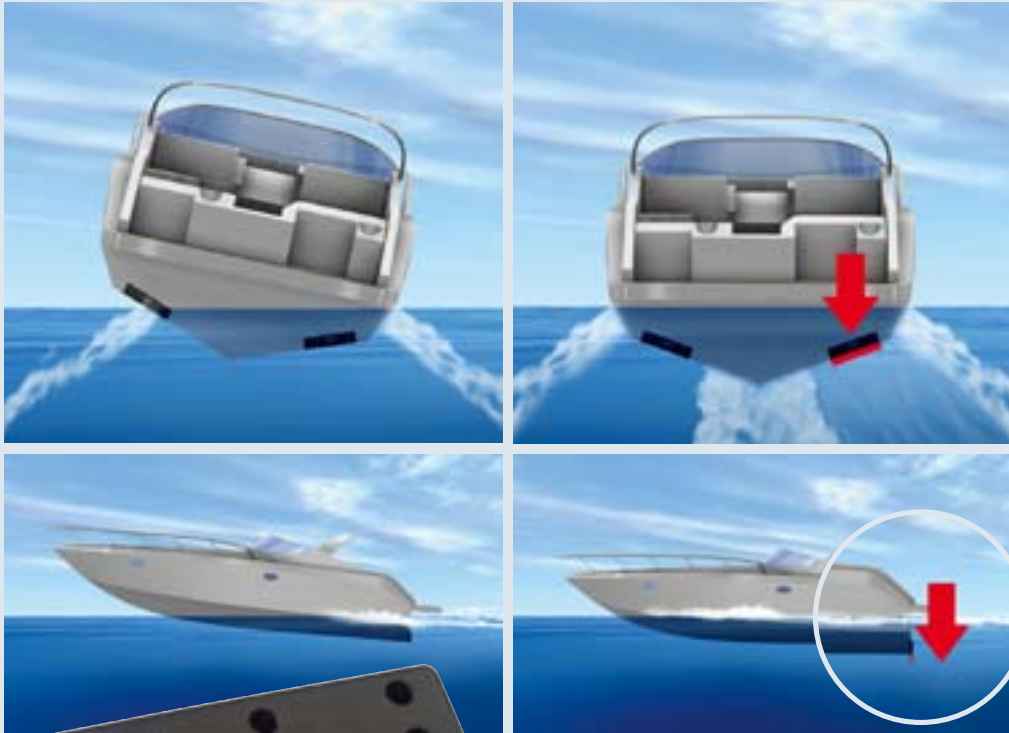

Boat Trim System

Perfect control over pitch and heel with rapid response, quicker onto the plane, lower fuel consumption and a more comfortable ride. That's what you get from the patented – and very user-friendly – Boat Trim System.

Thanks to the patented water intercept technology with vertical blades, you get a smoother ride and get quicker onto the plane. With composite material and no hydraulics involved, the Boat Trim System is corrosion free and practically no maintenance is required.



Electronically operated controls

For EVC engines. Smooth shifting, finger-tip control with minimal maintenance.

- Top-mount for single or twin installation, with or without powertrim function.
- Side-mount, for single installation, with or without powertrim function and safety lanyard.
- Palm Beach side-mount control in traditional sport fishing design. For twin installation.

Mechanically operated controls

Smooth operation year after year thanks to high-precision mechanics and low-friction control cables.

- Side-mount for single installation, with or without powertrim function and safety lanyard.
- Top-mount for single or twin installation, with or without powertrim function.



Electronic shift and throttle for mechanically operated engines

Gives you smooth shifting, finger-tip control with minimal maintenance. Fits most engines with mechanical shift and throttle, e.g. the D1 and D2.



Bow and stern thrusters

Complete high-quality range that gives maximum maneuvering power.

The thrusters are easy to operate and you can choose between joystick, lever/button and touch panel for single or multiple helms.

CT600 and CT900

Compact bow thruster with direct belt drive for high efficiency and reliability. Minimal maintenance thanks to no oil in the underwater unit, few moving parts and no anodes required.

Stern thruster

In combination with a bow thruster, the stern thruster improves boat maneuverability and greatly simplifies docking.

Thruster controls

Choose between joystick, lever/button and touch panel for single or multiple helms. Complement with remote control.

Boat length, feet

Bow thrusters	20	25	30	35	40	45	50	55	60	65	70
BP 300	●	●									
CT 600		●	●	●	●						
CT 900				●	●	●	●				
BP 1200						●	●	●	●	●	●
Stern thrusters											
SP 600		●	●	●	●						
SP 900				●	●	●	●	●			
SP 1300							●	●	●	●	●

● Table shows recommended thrusters according to boat length. Talk to your dealer or boat builder for exact calculations.

SAFETY

Engine room fan

Reliable and ignition-proof. Essential for evacuating fuel vapors.

Manual bilge pump

For safety reasons, you should always install a manual bilge pump.

Submersible bilge pump

Reliable and ignition-proof water-cooled motor.

Float switches

Boost safety, activating the pump as soon as bilge water is detected.

Safety lanyard

Stops engine if driver falls overboard.

Belt guard

Safe protection from moving parts on the engine.

Onboard kit

Pre-packed kits with the most common maintenance parts. Designed for each engine series and, of course, containing Genuine Volvo Penta Parts.

ONBOARD COMFORT

Water heater

Robust design in stainless steel that meets the highest sanitary requirements. Connected to the engine cooling system, it heats water with the excess engine heat. For 110 or 220 V shore power.

Air heater

Heats the cabin and/or defrosts the windshield by using the engine's excess heat.

Water pressure system

Equally suitable for fresh water and sea water. Automatic start and stop give low pulsation and long service life. Includes water supply pumps, filter and accumulator tank.

Wash-down and flexi pumps

Complete wash-down pumps for efficient onboard cleaning. Flexi pumps are versatile and can be used for many purposes.

Macerator pump

This toilet pump has a rotating knife that shreds waste material before it is pumped to a septic tank.

Sound absorbent

Highly efficient sound-absorbent panels made for marine environment.





PROPELLERS

Matched propellers

Each Volvo Penta propeller is a vital part of the propulsion package and developed exclusively for a specific drive and engine series. The design is unique, which results in high efficiency at all speeds, safe handling, easy maneuvering – and excellent onboard comfort.

Single propellers

The single propellers are made from aluminum or high-performance stainless steel and are available for right-hand and left-hand rotation.

Duoprop propellers

Twin, counter-rotating propellers – with patented blade design – give perfect handling, easy maneuvering, excellent grip and long drive-train life. Advanced materials are used to optimize the range for different needs. This year, we are introducing the new high-performing aluminum I series for DPS and OceanX drives.

Volvo Penta IPS propellers

Unique pulling propellers with a patented design. These twin, counter-rotating propellers are made from a specially developed nickel-bronze-aluminum alloy.

Propellers	Sterndrive					Pod	
	SX	DPS	DPH	DPR	OCEAN X	VOLVO PENTA IPS 350-600	VOLVO PENTA IPS 800-900
Type SX (single), 3-blade aluminum	●						
Type SX (single), 4-blade aluminum	●						
Type SX (single), 3-blade stainless steel	●						
Type I, aluminum		●			●		
Type F, stainless steel		●			●		
Type G, nickel-bronze-aluminum			●				
Type GR, stainless steel				●			
Type T, nickel-bronze-aluminum						●	
Type P, nickel-bronze-aluminum							●

ENGINE ACCESSORIES



Maintain powerful charging

For boaters needing increased charging capacity, there are solutions optimized for each engine.

Extra alternator

For 12 or 24 V system, matched for each engine.

Charging distributor

For efficient charging of multiple battery banks.

Power take-off

For powering auxiliary equipment.



Secure engine reliability

Unclean diesel, water or microorganisms in the fuel can all cause your engine to stop or fail to start. A pre-filter and a decontaminator are efficient ways to secure safe functionality – and reliability.

Fuel pre-filters

Efficient pre-filters protect the engine from water and particles. They are easy to inspect and clean for high reliability.

Diesel fuel decontaminator

Prevents microorganisms from clogging up the fuel system.

Lubrication, oil and coolant

Developed to meet the specific demands of Volvo Penta marine engines and transmissions. These products work perfectly in all operating temperatures and maintain their qualities also during long periods without use.



A wide accessory range

Volvo Penta offers a wide range of engine accessories. Here are just a few additional examples.

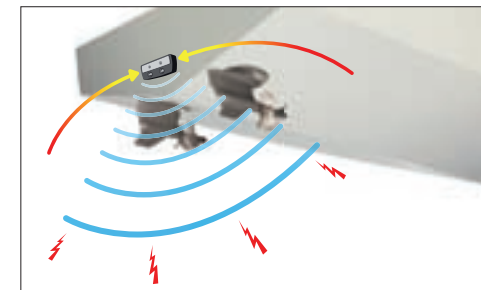

Active Corrosion Protection

The Active Corrosion Protection monitors the galvanic current flow in the water. When necessary, the system alerts and takes efficient counter measures to protect the metal parts exposed as well as extend the service life of the anodes.

The Active Corrosion Protection is a benefit in marinas where stray currents are present, which can cause galvanic corrosion. Available for Volvo Penta IPS and sterndrives.

Exhaust system

Complete system with silencers, hoses, elbows etc.

Cooling system





Complete system, outlet valves for air heater or water heater also available.

Neutra-Salt

Neutra-Salt Engine Flushing System, gives effective protection against internal corrosion.

EVC ACCESSORY PACKAGES

Complete packages for even better Drivability, Economy and Monitoring. Easy to install as everything needed is included from the start.

	 DRIVABILITY PACKAGES	 ECONOMY PACKAGES	 MONITORING PACKAGES
VOLVO PENTA IPS	Drivability main kit* <ul style="list-style-type: none"> Joystick, software 7" Color display Low-speed mode software Docking station kit <ul style="list-style-type: none"> Joystick, software EVC panel Dynamic Positioning System kit <ul style="list-style-type: none"> GPS receiver, software Sportfish mode <ul style="list-style-type: none"> Sportfish panel, software 	Economy main kit <ul style="list-style-type: none"> Trip Computer software NMEA 2000 interface Active Corrosion Protection kit <ul style="list-style-type: none"> Active Corrosion Protection main unit Software 	Included in Drivability main kit.
AQUAMATIC TWIN ENGINE	Drivability main kit <ul style="list-style-type: none"> Powertrim Assistant Rudder indicator, sender, interface kit Joystick kit <ul style="list-style-type: none"> Joystick, software Electronic steering Docking station kit <ul style="list-style-type: none"> Joystick, software EVC panel 	Economy main kit <ul style="list-style-type: none"> Trip Computer software NMEA 2000 interface 	Display kit* <ul style="list-style-type: none"> 7" Color display Mounting kit
INBOARD TWIN ENGINE	Drivability main kit <ul style="list-style-type: none"> Low-speed mode software Rudder indicator, sender 	Economy main kit <ul style="list-style-type: none"> Trip Computer software NMEA 2000 interface 	Display kit* <ul style="list-style-type: none"> 7" Color display Mounting kit
	 SINGLE ENGINE PACKAGES		
AQUAMATIC SINGLE ENGINE	Aquamatic single main kit** <ul style="list-style-type: none"> Powertrim Assistant Trip Computer software Multisensor 		Display kit* <ul style="list-style-type: none"> 4" Display NMEA 2000 interface
INBOARD SINGLE ENGINE	Inboard single main kit** <ul style="list-style-type: none"> Low-speed mode Trip Computer software Multisensor 		Display kit* <ul style="list-style-type: none"> 4" Display NMEA 2000 interface

*Top or flush mount **Hull or transom mount

DRIVE SYSTEM SPECIFIC OPTIONS

Drive specific options are presented in their respective section:

Volvo Penta IPS (page 14-17)

Joystick, Docking station, Dynamic Positioning System, Sportfish mode, Low-speed mode, Autopilot interface.

Aquamatic (page 18-25)

Joystick, Docking station, Powertrim Assistant, Tow mode (gasoline), Autopilot interface.

Inboard shaft (page 27)

Low-speed mode, Trolling.

DIESEL INBOARD

Engine	Crankshaft kW/hp	Propeller shaft kW/hp	Rated rpm	Displacement liters	No. of cylinders	High-pressure fuel injection	Aspiration	Electronic management	Constant power	Electronic shift/throttle	Freshwater cooling	Alternator 12V	Alternator 24V	Saildrive
D1-13	9.0/12.2	8.6/11.8	3200	0.5	2	-	N	-	-	□	●	115A ¹⁾	-	130S
D1-20	14/19	13/18	3200	0.8	3	-	N	-	-	□	●	115A ¹⁾	-	130S
D1-30	21/28	20/27	3200	1.1	3	-	N	-	-	□	●	115A ¹⁾	-	130S
D2-40	29/40	28/38	3200	1.5	4	-	N	-	-	□	●	115A ¹⁾	-	130S
D2-55	41/55	39/53	3000	2.2	4	-	N	-	-	□	●	115A ¹⁾	-	130S
D2-75	55/75	53/72	3000	2.2	4	-	T	-	-	□	●	115A ¹⁾	-	150S
▶ D3-110	81/110	78/107	3000	2.4	5	CR	T/A/4V	EVC/EC	T/Q	●	●	150A	-	
▶ D3-150	110/150	107/146	3000	2.4	5	CR	T/A/4V	EVC/EC	T/Q	●	●	150A	-	
▶ D3-170	125/170	121/165	4000	2.4	5	CR	T/A/4V	EVC/EC	T/Q	●	●	150A	-	
▶ D3-200	147/200	143/194	4000	2.4	5	CR	T/A/4V	EVC/EC	T/Q	●	●	150A	-	
▶ D3-220	162/220	157/213	4000	2.4	5	CR	T/A/4V	EVC/EC	T/Q	●	●	150A	-	
D4-180	132/180	128/174	2800	3.7	4	CR	T/A/4V	EVC/EC	T/Q	●	●	115A ¹⁾	-	
D4-225	165/225	160/218	3500	3.7	4	CR	T/A/4V	EVC/EC	T/Q	●	●	115A ¹⁾	-	
D4-260	191/260	186/253	3500	3.7	4	CR	T/A/4V	EVC/EC	T/Q	●	●	115A ¹⁾	-	
D4-300	221/300	212/288	3500	3.7	4	CR	T/A/4V	EVC/EC	T/Q	●	●	115A ¹⁾	-	
D6-330	243/330	237/322	3500	5.5	6	CR	T/A/4V	EVC/EC	T/Q	●	●	115A ¹⁾	80A ¹⁾	
D6-370	272/370	267/363	3500	5.5	6	CR	T/A/4V	EVC/EC	T/Q	●	●	115A ¹⁾	80A ¹⁾	
D6-435	320/435	310/422	3500	5.5	6	CR	T/A/K/4V	EVC/EC	T/Q	●	●	115A ¹⁾	80A ¹⁾	
D9-500	368/500	357/486	2600	9.4	6	UI	T/A/4V	EVC/EC	T	●	●	115A ¹⁾	80A ¹⁾	
D9-575	423/575	410/558	2500	9.4	6	UI	T/A/4V	EVC/EC	T	●	●	115A ¹⁾	80A ¹⁾	
D11-670	493/670	478/650	2300	10.8	6	UI	T/A/4V	EVC/EC	T	●	●	-	80A ¹⁾	
D12-715	526/715	510/694	2300	12.1	6	UI	T/A/4V	EVC/EC	T	●	●	-	80A ¹⁾	
D12-800	570/775	553/752	2300	12.1	6	UI	T/A/4V	EVC/EC	T	●	●	-	80A ¹⁾	
▶ D13-900	662/900	636/864	2300	12.8	6	UI	T2/A/4V	EVC/EC	T	●	●	-	110A ¹⁾	

▶ New ● Standard ○ Option □ Accessory

High-pressure fuel injection

UI: Unit injectors

CR: Common rail fuel injection

Fuel delivery

2-BBL: Two-barrel carburetor

MPI: Multi-port electronic fuel injection

Electronic management

EVC: Electronic Vessel Control, a CAN-bus-based boat management system for drive line control including engine management, diagnostic function, instrumentation, accessories etc.

EVC/EC: Full EVC with electronic shift and throttle.

EVC/MC: Full EVC for mechanical shift and throttle.

EVC/I: Interface for EVC-instrumentation.

Aspiration

N: Naturally aspirated

A: Aftercooler

T: Turbocharger

K: Compressor

T2: Dual-stage turbochargers

4V: 4 valves per cylinder

Constant power

T: Temperature compensation. Constant power output regardless of fuel temperature (5-55°C).

Q: Quality compensation. Constant power output regardless of fuel viscosity (heavy, regular or environmentally adapted fuel).

Fuel consumption

Estimated fuel consumption can be found in the Product Bulletin for each engine, available on volvopenta.com. For estimated fuel consumption for a specific boat model, consult the boat dealer.

Transmissions

A wide selection of Volvo Penta marine gearboxes is available for all diesel inboard engines, including straight or down-angle output shafts, mechanically or hydraulically operated. Saildrive is available for engines from 12 to 75 hp.

Volvo Penta IPS comes as a complete propulsion system with gearbox and propulsion unit.

VOLVO PENTA IPS

Diesel

IPS350	191/260	182/248	3500	3.7	4	CR	T/A/K/4V	EVC/EC	T/Q	●	●	115A ¹⁾	-	
IPS400	221/300	212/289	3500	3.7	4	CR	T/A/K/4V	EVC/EC	T/Q	●	●	115A ¹⁾	-	
IPS450	243/330	230/314	3500	5.5	6	CR	T/A/K/4V	EVC/EC	T/Q	●	●	115A ¹⁾	80A ¹⁾	
IPS500	272/370	259/352	3500	5.5	6	CR	T/A/K/4V	EVC/EC	T/Q	●	●	115A ¹⁾	80A ¹⁾	
▶ IPS600	320/435	307/418	3500	5.5	6	CR	T/A/K/4V	EVC/EC	T/Q	●	●	115A ¹⁾	80A ¹⁾	
▶ IPS800	441/600	417/567	2300	10.8	6	UI	T/A/K/4V	EVC/EC	T	●	●	-	80A ¹⁾	
▶ IPS900	515/700	487/662	2350	10.8	6	UI	T/A/K/4V	EVC/EC	T	●	●	-	80A ¹⁾	

Gasoline with catalytic converter

IPS550G*	298/400	280/376	4800	8.1	V8	MPI	N	EVC/EC	-	●	●	120A	-	
----------	---------	---------	------	-----	----	-----	---	--------	---	---	---	------	---	--

¹⁾ With built-in charging sensor * Only available in selected markets

DIESEL AQUAMATIC

Engine	Crankshaft kW/hp	Propeller shaft kW/hp	Rated rpm	Displacement liters	No. of cylinders	High-pressure fuel injection	Aspiration	Electronic management	Constant power	Electronic shift/throttle	Freshwater cooling	Alternator 12V	Aquamatic drive	X-act steering	Propellers*
▶ D3-140	103/140	98/133	4000	2.4	5	CR	T/A/4V	EVC/EC	T/Q	●	●	150A	SX/DPS	-	AL, SS
▶ D3-170	125/170	119/162	4000	2.4	5	CR	T/A/4V	EVC/EC	T/Q	●	●	150A	SX/DPS	-	AL, SS
▶ D3-200	147/200	140/190	4000	2.4	5	CR	T/A/4V	EVC/EC	T/Q	●	●	150A	DPS	-	AL, SS
▶ D3-220	162/220	154/209	4000	2.4	5	CR	T/A/4V	EVC/EC	T/Q	●	●	150A	DPS	-	AL, SS
D4-225	165/225	158/215	3500	3.7	4	CR	T/A/4V	EVC/EC	T/Q	●	●	115A ¹⁾	DPH	●	NBR
D4-260	191/260	184/250	3500	3.7	4	CR	T/A/K/4V	EVC/EC	T/Q	●	●	115A ¹⁾	DPH	●	NBR
D4-300	221/300	214/291	3500	3.7	4	CR	T/A/K/4V	EVC/EC	T/Q	●	●	115A ¹⁾	DPH/DPH	●	NBR/SS
D6-330	243/330	233/317	3500	5.5	6	CR	T/A/4V	EVC/EC	T/Q	●	●	115A ¹⁾	DPH	●	NBR
D6-370	272/370	261/355	3500	5.5	6	CR	T/A/K/4V	EVC/EC	T/Q	●	●	115A ¹⁾	DPH/DPH	●	NBR/SS

¹⁾ With built-in charging sensor

* Not included

Aquamatic drives

SX: Single propeller. For gasoline engines and D3.

Small transom cut-out.

DPS: Duoprop. For gasoline engines and D3.

Small transom cut-out.

DPH: Duoprop. With X-act steering, specially developed for the D4 and D6 engines. Large transom cut-out.

DPH: Same as DPH but with a lower housing adapted

for speeds in excess of 45 knots. Large transom cut-out.

X-act steering

Servo-assisted hydraulic steering with external steering cylinders controlled by an exact feedback valve.

Propellers

AL: Aluminum

SS: Stainless steel

NBR: Nickel-bronze-aluminum alloy

Product bulletins with more detailed information available at your dealer or www.volvopenta.com

GASOLINE AQUAMATIC

Engine	Propeller shaft kW/hp	Max rpm	Displacement liters	No. of cylinders	Fuel delivery	Electronic management	Electronic shift/throttle	Freshwater cooling	Alternator 12V	Aquamatic drive	X-act steering	Propellers*
3.0GL	100/135	4600	3.0	I-4	2-BBL	-	□	-	75A	SX	-	AL, SS
3.0GX ^{***}	112/150	4800	3.0	I-4	MPI	-	□	-	75A	SX	-	AL, SS
4.3GL	141/190	4600	4.3	V6	2-BBL	-	□	○	75A	SX/DPS	-	AL, SS
4.3GX ^{iE}	168/225	4800	4.3	V6	MPI	EVC/EC ^{**}	□	○	75A	SX/DPS	-	AL, SS
5.0GL ^{***}	164/220	4800	5.0	V8	2-BBL	-	□	○	75A	SX/DPS	-	SS
5.0GX ^{iE}	201/270	5000	5.0	V8	MPI	EVC/EC ^{**}	□	○	75A	SX/DPS	-	SS
5.7GiE-300	224/300	5000	5.7	V8	MPI	EVC/EC ^{**}	□	○	75A	SX/DPS	-	SS
5.7GX ^{iE}	239/320	5200	5.7	V8	MPI	EVC/EC ^{**}	□	○	75A	SX/DPS	-	SS
8.1GiE	280/375	4600	8.1	V8	MPI	EVC/EC ^{**}	□	○	75A	DPS	-	SS
8.1GX ^{iE}	313/420	5000	8.1	V8	MPI	EVC/EC ^{**}	□	○	75A	DPS	-	SS

Engines with catalytic converter

3.0GX ^{iC}	112/150	4800	3.0	I-4	MPI	-	□	-	75A	SX	-	AL, SS
5.0GX ^{iCE}	201/270	5000	5.0	V8	MPI	EVC/EC ^{**}	●/○	○	75A	SX/DPS	-	SS
5.7GiCE-300	224/300	5000	5.7	V8	MPI	EVC/EC ^{**}	●/○	○	75A	SX/DPS	-	SS
8.1GiCE	298/400	4800	8.1	V8	MPI	EVC/EC ^{**}	●/○	○	75A	DPS	-	SS

* Not included

** Standard or option depending on market. Check with your local Volvo Penta representative.

*** Only available in selected markets



Thanks to state-of-the-art engine technology throughout, the entire D series diesel engine range complies with the most stringent environmental demands in their respective power class:

- The US EPA Tier 2 for D3 to D13 and Tier 3 for D1 and D2, two regulations significantly more stringent than the European RCD regulation.

All our gasoline engines comply with:

- The European RCD regulation.

Models with catalytic converter also with:

- CARB 4 Star Super Ultra Low Emission.

GLOBAL DEALER NETWORK

As a Volvo Penta owner, you have one, single contact for everything: engines, instruments, accessories, service, warranties, etc. This means simpler ownership – and more time for boating. With every Volvo Penta engine comes the support of a global dealer network – present in more than 130 countries.



Volvo Penta Action Service



Volvo Penta Action Service is a unique service for all Volvo Penta owners. With this telephone service for rapid support, we offer round-the-clock availability, 365 days per year. Volvo Penta Action Service is available in Europe and North America.

Extended protection

Warranties and extended protection for Volvo Penta engines give you years of protection depending on local conditions. Contact your dealer for more information and for activating the extended protection.



**VOLVO
PENTA**

www.volvopenta.com